

## The parabolic trough power plants Andasol 1 to 3

*The largest solar power plants in the world –*

*Technology premiere in Europe*





## Table of contents

<b>Solar energy and solar-thermal power plants</b>	<b>4</b>
<b>The first parabolic trough power plants in Europe – the world's largest solar power plants: Andasol 1 to 3</b>	<b>8</b>
<b>Regulatory framework in Spain</b>	<b>20</b>
<b>Project partners</b>	<b>22</b>



## Solar energy and solar-thermal power plants

Europe's energy supply today is highly dependent on the availability of low-cost, conventional energy sources such as natural gas, oil and coal. The general political consensus is that the energy-production system now desperately needs to be overhauled. The reasons for this are well known. Oil and natural gas supplies are limited. Other sources of fuel such as uranium or coal are also finite. In addition, conventional energy production causes global warming which is a result of greenhouse gas emissions, primarily carbon dioxide.

Rising energy consumption worldwide is increasing the severity of this development; the International Energy Agency (IEA) estimates that by 2030, consumption will increase by 50%. Furthermore, a World Energy Council study estimates an increase of 70% to 100%, by 2050. Energy saving measures such as increasing the efficiency of electronic devices and machines could ease the situation. At the same time, energy around the globe needs to be produced on a sustainable basis, which can only be achieved through the extensive use of renewable energy sources.

Each year, the sun sends over a billion terawatt hours of energy to the Earth, which is equal to 60,000 times the world's electricity needs. From a mathematical perspective, less than three percent of the surface area of the Sahara would be sufficient

to meet to the world's energy demand with solar power plants. In this way, the solar radiation that reaches the earth's surface every day offers far more potential than any other renewable energy source. Solar energy can be utilized by different means. In Germany, photovoltaic arrays are used primarily for power generation and solar-thermal collectors for producing hot water. The solar-thermal principle i.e. solar heat usage, offers many more far-reaching possibilities. Solar-thermal power plants transform heat from the sun into electricity. This is done in large-scale power plants with a capacity of up to 250 megawatts per plant. The technology has an important advantage over some other forms of renewable energy such as photovoltaic or wind energy in that thermal energy can be stored far more cost-effectively and efficiently than electricity. By using thermal storage, solar-thermal power plants can provide power on demand, both when the sky is overcast and at night. In this way, electricity production can be achieved almost round the clock in summer. In the long-term, fossil-fuel power plants are being replaced. Until the fossil fuel power plant becomes obsolete, solar-thermal power plants can be combined with conventional power plants (hybrid operations) to reduce climate-damaging greenhouse gasses.

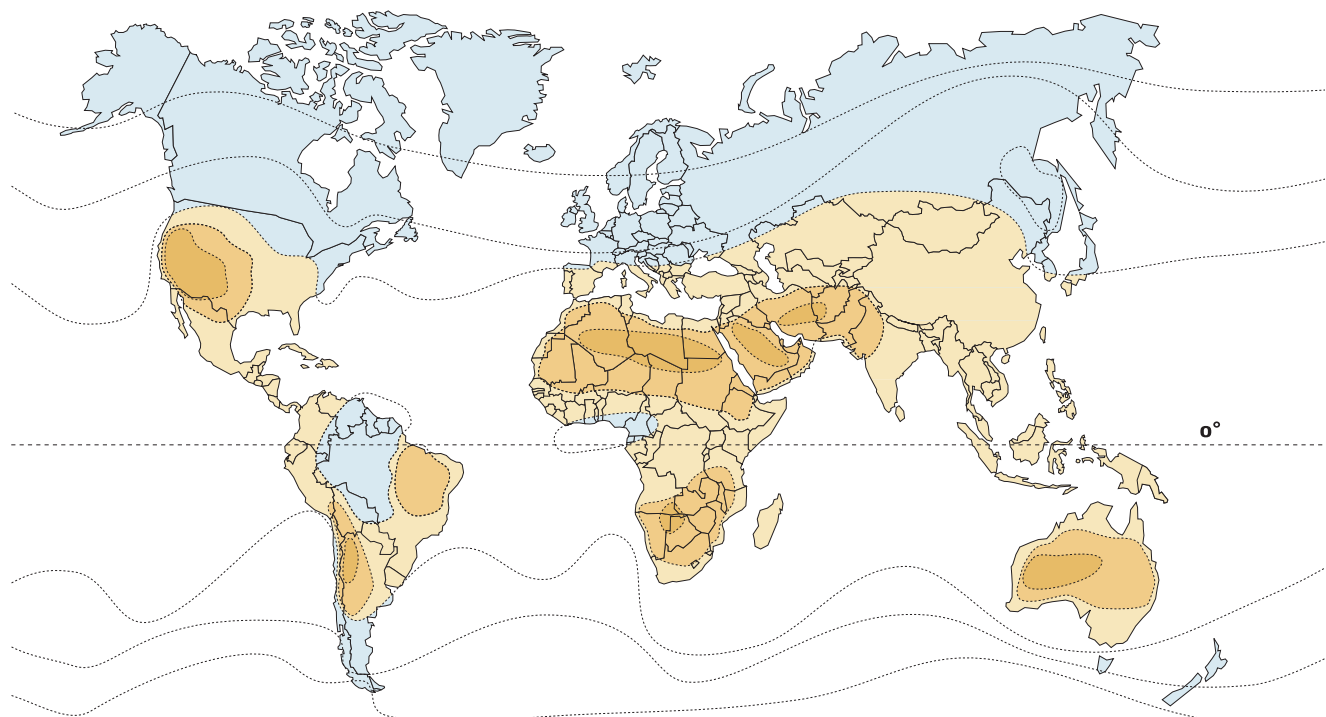

Additionally, solar-thermal power plants can be used for other applications, such as combining them with desalination plants to produce not only solar power in sunny regions, but also helping to provide valuable drinking water, which is often a scarce commodity in these regions. Furthermore, the plants are also suitable for producing steam, heat, or cooling for industrial applications.

**Market forecast**

Today, solar-thermal power plants require state support e.g. in the form of feed-in tariffs, to secure their competitive viability. In a few years the technology will probably no longer require such support and will thus be able to compete with fossil-fuel peak-load and medium-load power plants. Larger market volumes and technical advances will also lead to lower costs for components.

Studies by renowned institutions have indicated that strong growth is predicted for solar-thermal power plants. The overall capacity of installed solar-thermal power plants will increase to at least 20,000 megawatts by 2020 (see graph below).

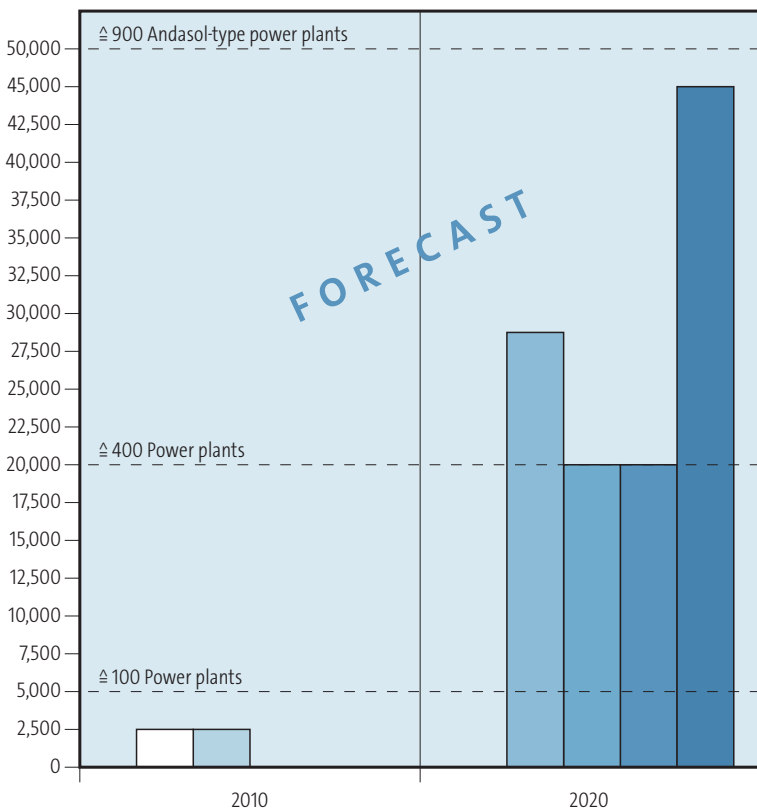

**Sample global energy mix in the year 2100**

Source: German Advisory Council on Global Change, 2003

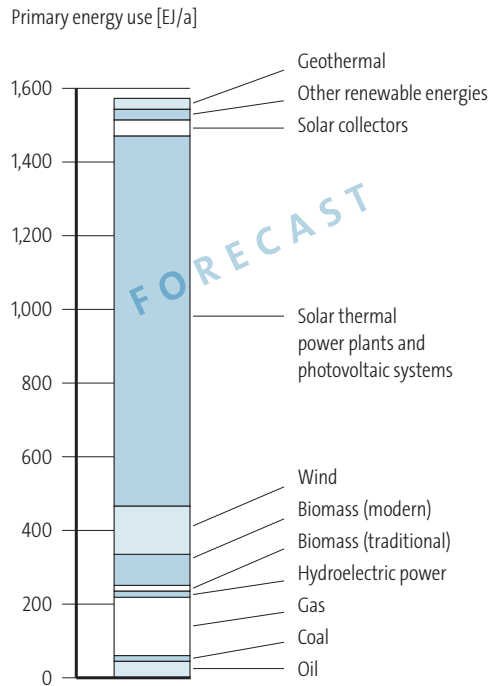

The majority of the global energy demand can be covered in the long run through the use of solar energy.

The German Advisory Council on Global Change (WBGU) has created a primary energy mix forecast for the year 2100 (source: WBGU 2003).

The “MED-CSP” study by the German Aerospace Center (DLR) assumes that by 2025, most renewable energy sources will be cheaper than those supplied by fossil fuels. By the middle of this century, renewable energy will have largely replaced fossil-fuel based sources of energy in the Mediterranean region. Though the study endorsed a general mix of renewable energy, it indicated that solar-thermal power plants will play the most important role. According to the DLR study, their capacity in the Mediterranean region will be as large as the combined wind, photovoltaic, biomass, and geothermal power stations. Solar-thermal power plants can produce up to double the amount of energy when equipped with thermal storage.

- Studies**
- Greenpeace/ESTIA 2005
  - Sarasin 2007
  - Greenpeace EREC 2007
  - US Department of Energy
  - IEA min.
  - IEA max.

Spain has played a pioneering role in solar-thermal power plants in Europe over the last few years and is now the largest market. The unanimous opinion of market participants is that the next large market will be the south west of the United States. There, the first commercial power plants worldwide have been producing solar electricity reliably for over 20 years. Further plants are now under construction in North Africa and the Middle East. The first projects are also being developed in Asia. Solar Millennium in China has signed a framework agreement with companies in the region for the construction of a total of 1,000 MW of solar-

### Technology

Solar heating is the term used to describe the conversion of incidental solar radiation to heat energy. In Germany, this principle is utilized to produce hot water using roof collectors. In sunny countries, the concentration of direct radiation in parabolic trough power plants leads to such high temperatures, that the energy can be used in steam turbines to produce electricity. In solar-thermal power plants, steam is produced by concentrated solar radiation instead of burning fossil fuels. In contrast to power generated by

---

The amount of energy provided by the sun is immense and it can be used in a targeted way. The following effect is familiar to everybody. Focusing the sun's rays with a magnifying lens allows temperatures to be achieved that can set paper alight. Parabolic trough power plants create same effect and focus the sun's rays using parabolic mirrors. This allows solar energy to be utilized on a large scale, so that oil, gas, coal and nuclear power can be replaced long-term as sources of fuel.

---

thermal power plant capacity. The Solar Millennium Group is also involved in the construction of Egypt's first parabolic trough power plant.

The amount of energy provided by the sun is immense and it can be used in a targeted way. The following effect is familiar to everybody. Focusing the sun's rays with a magnifying lens allows temperatures to be achieved that can set paper alight. Parabolic trough power plants create same effect and focus the sun's rays using parabolic mirrors. This allows solar energy to be utilized on a large scale, so that oil, gas, coal and nuclear power can be replaced long-term as sources of fuel.

An intercontinental electricity federation would be able to connect the best renewable energy sources in Europe with one another, e.g. solar energy from North Africa would be connected with off-shore wind parks and Scandinavian hydro-electric power plants. A low-loss high-voltage network using high-voltage direct-current transmission could provide efficient transport of electricity. The German Aerospace Center (DLR) concluded its study of electricity grids by stating that, "By 2050, twenty lines in the MENA (Middle East and North Africa) could use solar power to supply about 15% of European electricity needs".

wind or photovoltaic sources, power derived from solar-thermal power plants can be supplied in a cost-efficient and plannable way, thanks to the use of thermal storage tanks or co-firing. Thus, solar power plants can also generate electricity after sunset.

### Parabolic trough power plants are proven and reliable technology

The main element of a parabolic trough power plant is the solar field, which provides steam for conventional steam turbines. It consists of numerous parallel rows of solar collectors, arranged on a North-South axis. They then follow the path of the sun from east to west. The reflectors consist of parabolic mirrors made from extremely transparent, silver-coated glass. They concentrate the incident solar radiation 80-fold, focusing it onto an absorber pipe in the focal line of the collector. The metal structure, mirror elements, and absorber pipe together form a high-precision optic device. The absorption pipe contains a heat transfer medium, which is a temperature-stable synthetic oil in a closed circuit that can be heated to temperatures of up to 400 degrees Celsius. Once heated, the oil is pumped to a centrally located power block, where it flows through a

heat exchanger. The remainder of the process is similar to the steam cycle used in conventional power plants. The steam produced by the heat exchanger is used to drive a turbine connected to a generator. The steam in the turbine condenses back into water and the water is then re-circulated. Up to now, parabolic trough technology has been the only large-scale solar power plant technology to have proven reliable over a longer period of time. The power plants are above-average in terms of annual efficiency with very low power production costs in relation to other solar technologies. The first commercial parabolic trough power plants with a total capacity of 354 MW have already been in operation for over 20 years in California's Mojave Desert (USA). The Andasol Power Plants in southern Spain are the first parabolic trough power plants in Europe. In terms of collector area, they are the world's largest solar power plant in the world to date.

#### **Low energy amortization periods**

The energy amortization period is used to measure the time a power plant needs to produce the energy required to build the power plant itself. Solar thermal power plants have a relatively short amortization period of about five months, which is low compared to other forms of renewable energy. The time required for wind power is 4 to 7 months and 2 to 5 years are needed for photovoltaic power plants. In addition, solar-thermal power plants distinguish themselves in that they require little specific surface area calculated in terms of the amount of energy produced per square meter.





## The first parabolic trough power plants in Europe – The largest solar power plants in the world – Andasol 1 to 3



### Data about the Andasol-power plants (Data per power plant)

#### Location

Project names	Andasol 1, Andasol 2, Andasol 3
Location	10 km east of Guadix in the municipal area of Aldeire and La Calahorra in the Marquesado del Zenete region, Granada Province
Terrain	approx. 195 hectares (1300m x 1500M), North-South Axis
High-voltage line access	Connection to the 400kV line near Huéneja (about 7 km away)

#### Solar Field

Parabolic trough technology used	Skal-ET
Size of the solar field	510,120 m <sup>2</sup>
Number of parabolic mirrors	209,664 mirrors
Number of receivers (absorption pipes)	22,464 pipes each measuring 4 m
Number of solar sensors	624 sensors
Annual direct standard radiation (DNI)	2,136 kWh/m <sup>2</sup> a
Solar field efficiency	approx. 70% peak efficiency, approx. 50% annual average
Heat storage capacity	28,500 t salt for 7.5 peak load hours

#### Power plant capacity

Turbine capacity	49.9 MW
Annual operating hours	approx. 3,500 peak load hours
Forecast gross electricity volume	about 180 GWh
Efficiency of entire plant	approx. 28% peak efficiency, approx. 15% annual average
Estimated lifespan	at least 40 years



The Andasol power plants are being built in the southern Spanish province of Andalusia. Andasol 1 is the first parabolic trough power plant in Europe and the largest in the world to date, when viewed in terms of its collector area of over 510,000 square meters. Three similarly constructed power plants

are planned for this site. Each with a capacity of 50MW, they will produce enough combined environmentally friendly solar electricity for up to 600,000 people. This will reduce carbon dioxide emissions by 450,000 tons a year.

### **Andasol power plants honored with the Energy Globe Award at the European parliament**

For its initiating and development of the Andasol power plant projects (the first parabolic trough power plants in Europe), Solar Millennium was awarded the Energy Globe Award in the "Fire" category in May, 2008. The worldwide renowned environment prize honored the projects' innovative character and its major contribution to climate protection. The Energy Globe Award in the "Fire" category is awarded to innovative projects for environmentally-friendly power production. The awards ceremony took place in the Plenary Hall of the European Parliament in the form of an internationally broadcast television gala in Brussels. The fact that all three European institutions were represented by their presidents gave the event special importance: José Manuel Barroso (EU Commission), Hans-Gert Pöttering (EU Parliament) and the Slovenian Prime Minister, Janez Janša (EU Council) were all present at the event. Michail Gorbachov received an Energy Globe Award for his life's work. Former UN General Secretary, Kofi Annan and singer Dionne Warwick appeared as prominent speakers during the ceremony. Since 1999, the Energy Globe Award has been given to projects which protect natural resources or use renewable energy sources. Around 800 projects and initiatives enter the competition each year in the categories of Earth, Fire (electricity), Water, Air and Youth.



*Dr. Henner Gladen and Thomas Mayer, Board Members of Solar Millennium AG, pleased about the Energy Globe Award*



#### **Location**

The Andasol power plants are located on the Guadix plateau in the Spanish province of Granada within the municipality of Aldeire. The site's coordinates are 37°13' N; 3°04' W. The site is located at an elevation of between 1,090 and 1,100 meters above sea level. The area has been excavated and is free from any shading. The site is located directly on the A92 motorway running from Guadix to Almeria. No residential buildings are located adjacent to the site of the power plant. The closest town is La Calahorra. According to a geo-technological study carried out in 2003, the ground is very solid.

#### **Solar resources**

The decisive factor for the economic viability of a solar investment is the annual electricity production, which depends to a great extent on the solar radiation resources locally available. The strength of direct solar radiation, i.e. radiation which penetrates the atmosphere unscattered, is relevant for parabolic trough power plants and thus important for focusing solar thermal technology. In order to evaluate the intensity of solar radiation at the Andasol power plant's site, measurements were made on site and the evaluation of long-term satellite data was carried out. An RSP Sensor (Rotating Shadowband Pyranometer) was used in the on-site measuring station. It is a special measuring device that determines global solar radiation as well as the direct solar radiation. In addition, meteorological stations were used to measure ambient temperature, humidity, wind direction and wind speed. The German Aeronautics Center (DLR) regularly checked the sensors in use to determine and ensure their accuracy. The sensors were also calibrated with a precision measuring station. The measuring stations were specially developed by Solar Millennium for determining the suitability of potential solar-thermal power plant sites. They are characterized by a high

degree of accuracy in measurement, independent operations, and low maintenance. The radiation data was collected at one-minute intervals providing the project team with very precise data for the project development. Renowned research institutes around the world have put in requests for Solar Millennium's meteorological stations and they are now being used at about 40 sites around the world. The meteorological measuring station at the Andasol site has been in operation since March 2000. The radiation values measured are entered in the graph below. In addition to the local measurement data, satellite data was included to determine a long-term mean value for solar radiation at the site. Satellite data from the DLR for the period from 1983 to 2001 was also evaluated and then the direct radiation was extrapolated from it. Using the satellite data and the locally measured data, a long-term medium value of 2,144 kWh per square meter annually was extrapolated.

The measuring station at the Andasol site will continue to be in use after the commissioning of the power plant, providing information for plant operation, like wind speed, for example.

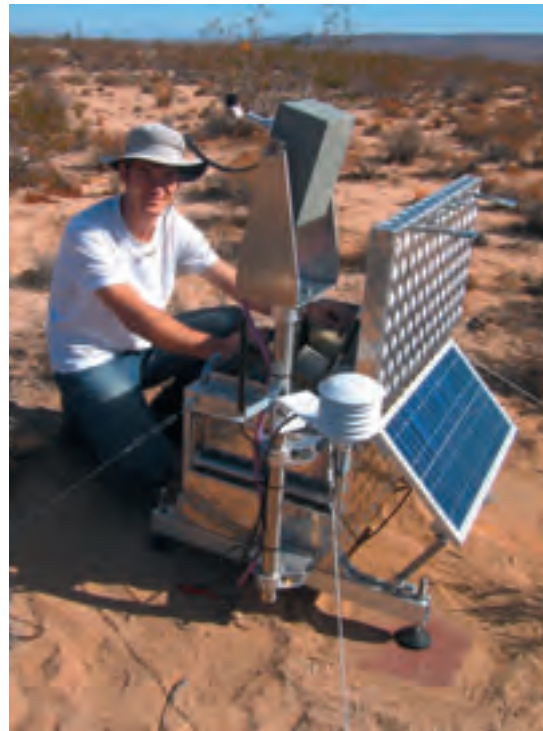

One of Solar Millennium AG's meteorological measuring stations

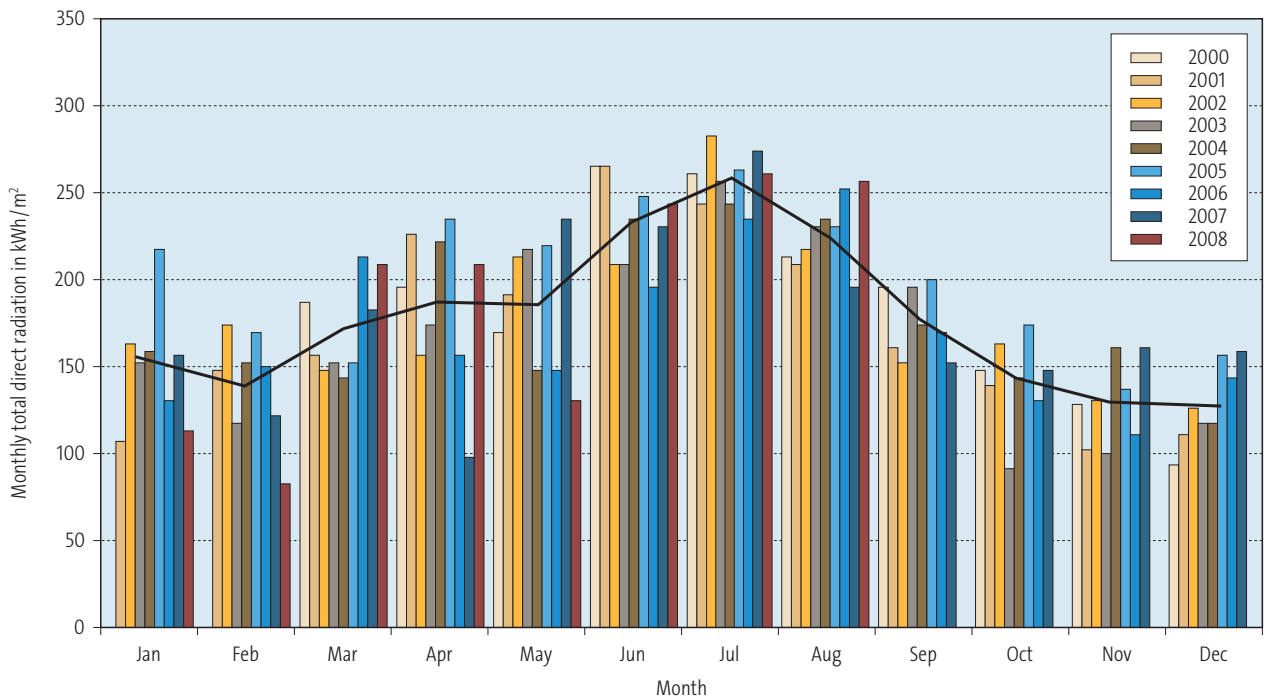



### Water availability

The power plant's site is unique in Spain for its comparatively above-average water availability. The Sierra Nevada mountain range which surrounds the site is the primary source. The Andasol power plant's annual water needs are about equal to the water which would be needed for the cultivation of crops such as wheat on the power plant's site. The plant requires about 870,000 m<sup>3</sup> of water per year, which is mainly used for cooling the steam circuit, i.e. from the vaporization of water in the cooling towers. The water needs are primarily met with ground water extracted from wells on the site.

### Technical description

In parabolic trough power plants, trough-shaped mirrors in the solar field concentrate the sun's rays by a factor of 80 onto an absorption pipe in the focal line of the collector. In the pipes, a heat transfer fluid circulates in a closed circuit which is heated to 400 degrees Celsius by the concentrated solar radiation. The heated fluid is then pumped into a centrally located power block and flows through a heat exchanger. In this way, steam is generated which (similar to conventional power plants) powers the turbine using an electric generator. The integration of a heat storage allows the power plant to function at full capacity both on overcast days and at night. The Andasol power plants each consist of a solar field, a thermal storage tank, and a conventional power plant section.

### Solar field transforms solar radiation into heat energy

An Andasol power plant has a solar field that covers 510,120 square meters. The parabolic troughs are set up in 312 collector rows which are connected by pipes. The rows are set up on a north-south axis and follow the course of the sun from east to west. One row is made up of two collector units. Every collector unit has its own solar sensors and hydraulic drives, which allow the mirrors to track the position of the sun. The collector units each have 12 collectors, which are 12 m long and 6 m wide. Every collector has 28 mirrors and 3 absorption pipes. An Andasol power plant requires 7,488 collectors. Specialists assemble and check these collectors photogrammetrically to determine their precision in specially-constructed factory buildings before the collectors are brought to the field and anchored.

### Efficiency

Solar field	
Peak efficiency	ca. 70%
Annual average	ca. 50%
Turbine circuit	
Peak efficiency	ca. 40%
Annual average	ca. 30%
Entire plant	
Peak efficiency	ca. 28%
Annual average	ca. 15%

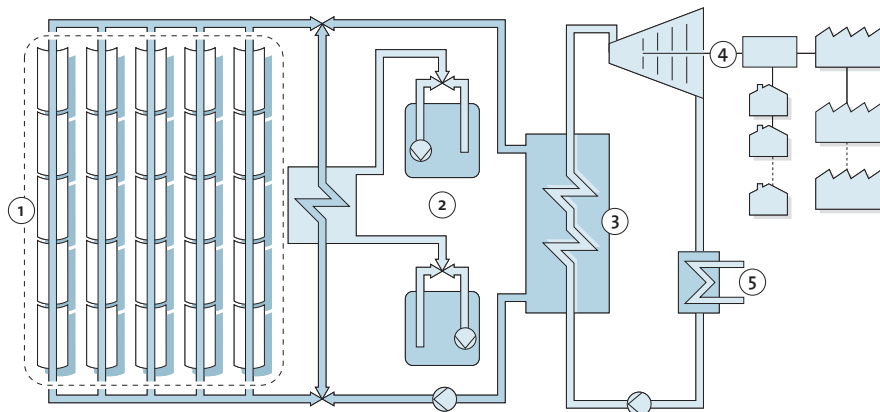

1. Solar field, 2. Storage, 3. Heat exchanger, 4. Steam turbine and generator, 5. Condenser

**Thermal storage tanks allow for planned electricity production**

A portion of the heat produced in the solar field at the Andasol power plant is not transferred to the steam circuit but stored as liquid salt. A mixture of about 28,500 tons of potassium, sodium, and nitrate salts are heated during the day when the sun is shining and can then provide the necessary heat to operate the power plants at night or during overcast periods. In addition, the molten salt mixture has an outlet temperature of about 290 degrees Celsius and can be heated up to 390 degrees Celsius. Each power plant has two tanks, which function like a thermos flask and are able to assure that the salt maintains its temperature over several weeks. A full thermal salt reservoir

can be used to operate a power plant turbine for about 7.5 hours. This allows for almost round the clock operations in the summer months. In order to fill the thermal storage tanks while simultaneously operating the turbines, the power plant's solar field is significantly larger than that of a power plant without a storage tank. The annual operating hours of the solar power plant at peak load operation can be almost doubled in this way.

The thermal storage system is loaded during the day.

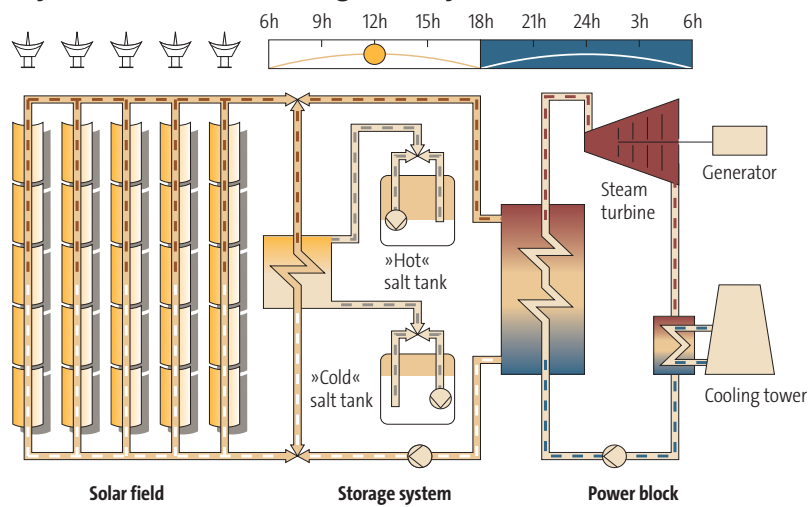

During the night, the power plant can be operated with the stored energy.

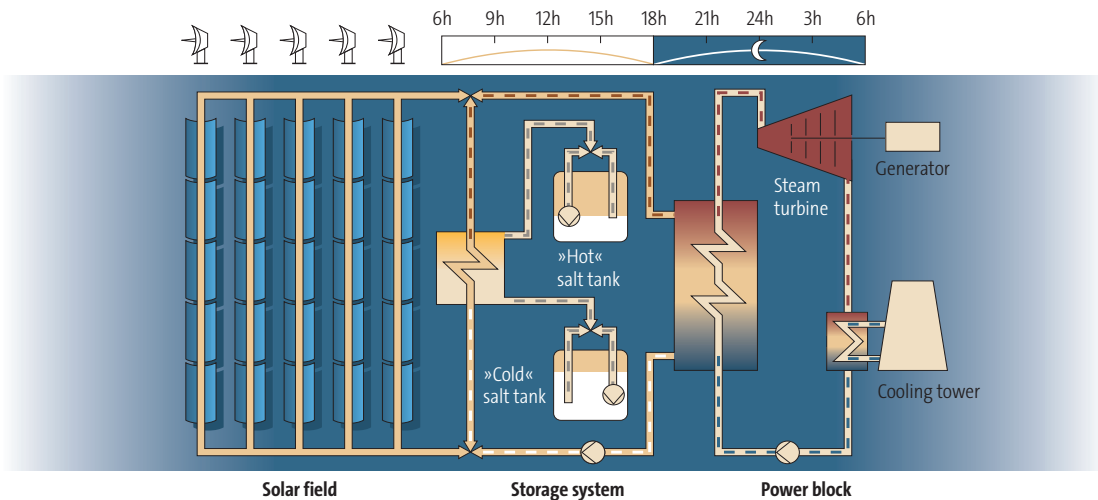



**More than two decades of experience with technology in California**

In California, nine parabolic trough power plants (SEGS I-IX) were built between 1984 and 1990; creating a total capacity of 354 MW. Up to now, these nine power plants have produced more than 12,000 GWh of electricity, and netted over \$2 billion from feeding electricity into the California power grid. This solar electricity volume represents a significant portion of the solar power volume currently being produced throughout the world. The remainder is produced by hundreds of thousands of photovoltaic plants. The power plants in California's Mojave Desert have a proven long-term availability of about 99%. They also illustrate the long-term durability of the components and the low operating and maintenance costs generated by them. They are still operating successfully to this day. The condition of the power plants after twenty years of operation is immaculate, with power plant operators predicting that they will remain in operation for a very long period of time (see image above). Solar Millennium used data from operations and experience gained when conceptualizing the Andasol power plants. This data was supplemented by the results of a long-term study carried out by a consortium under the aegis of Solar Millennium. In the Californian

plants, two rows of collectors were erected with further developed collectors which have been in commercial operation since 2003.

**Size**

The Andasol power plants each cover an area of 195 hectares (about two square kilometers). Each power plant's solar field has 312 collector rows each with a collector area of 510,120 square meters (aperture surface). This is roughly equal to the area of 70 soccer fields. Approx. 90 kilometers of absorption pipes and curved mirrors with a total area of 580,500 square meters are also used. The difference between the collectors' aperture surface and the larger mirror surface area is due to the curve of the mirrors. The construction of the Andasol power plants is practically identical.

**Collectors**

Mirrors and absorption pipes are precisely mounted on steel support structures which, taken together, form the collectors. The metal support structure is anchored in the ground using a steel pylon. The hydraulic drives can adjust the 150 meter long collector chains with a precision of up to a tenth of millimeter allowing them to follow the sun on its daily course from east to west along a single axis. Computers in the control room are used to direct the power plant's collectors.



Information from each individual collector unit is transmitted during this process. The orientation during sunrise and sunset is carried out automatically. 624 sensors in the solar field combine to guarantee the precise control of each collector unit, allowing them to follow the course of the sun. Flagsol GmbH, Solar Millennium's technology company from Cologne, developed and supplied the sensors. The company also designed and supervised the solar field construction site. The collectors were constructed to withstand the most extreme weather conditions. The entire solar field can continue operating normally in winds of up to 13.6 m/s (about 49 km/h). Should wind speeds be higher, some of the collectors will be put in a wind-protected "sleep" position. During gales, i.e. wind speeds exceeding 20m/s (about 72 km/h) power plant operations will be halted entirely. At the Andasol location, winds exceeding 14.5 m/s (around 52 km/h) in the period from 2000 to 2007 were measured in less than 0.3% of the total daylight hours.

#### **Advanced collectors**

The Andasol power plants' technology was tested in the SEGS power plants in Kramer Junction, California. About 4,000 square meters of advanced Skal-ET collectors are used in Andasol and were also installed the SEGS V power plant was operating. A long-term study proved that the Skal-ET collectors are about 10% more efficient than the previous generation of collectors.

#### **Precise mounting of collectors**

Precise mounting of collectors is decisive for the efficiency of the solar field. In an assembly line, the parabolic mirrors and the mountings for the absorber pipes are attached to the steel support structure. The optical precision of the collectors will be controlled by a photogrammetric device at the end of the assembly line.

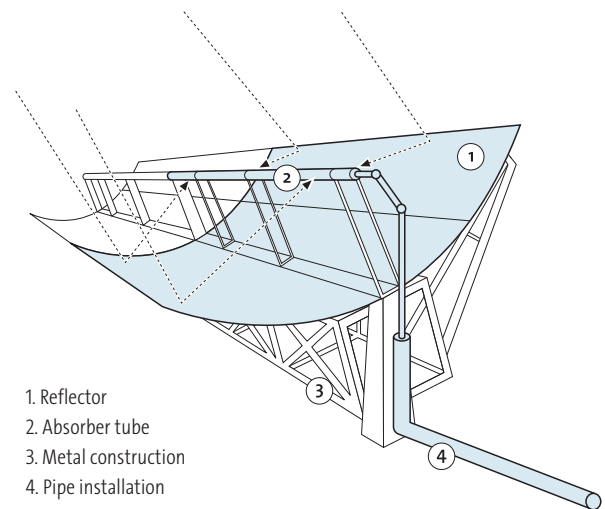



### **Turbines**

Turbines, generators and plant periphery are conventional power plant components, similar to those used in fossil fuel power plants. The Andasol power plant's turbine has a capacity of 50 megawatts and is specifically designed to ensure reliable operations during the daily start-up and shut down of the plant. Siemens in Sweden constructed the turbines for Andasol 1 and 2. MAN Turbo will supply the turbines for Andasol 3.

### **Absorption pipes**

The absorption pipes were conceived especially for use in parabolic trough power plants. They absorb the solar radiation reflected by the mirrors, transfer the solar energy into a heat transfer medium located in the pipe, which then transmits the heat into the steam circuit.

Schott Solar AG in Mainz, Germany and Solel Solar Systems Ltd. of Israel produced the absorption pipes used in the Andasol power plants. Solel has years of experience producing absorption pipes and supplied the absorption pipes for the parabolic trough power plant built in California at the end of the 1980's. Schott has also developed absorption pipes for parabolic trough power plants in recent years. Quality and capability have been shown

successfully since 2003 by a demonstration collector chain in California which was erected under the direction of Solar Millennium AG. Schott produces the absorption pipes for the power plant in Mitterteich, Bavaria. Schott developed a special glass for the direct transition between glass and metal and the glass has the same expansion characteristics as metal. This allows the absorption pipes to reliably withstand the temperature differences between cold nights and hot days.

This construction allows maximum absorption of solar radiation and simultaneously minimizes the reflex radiation of heat from the metal pipe. An absorption pipe is four meters long and composed of a multi-layered stainless-steel pipe, which Schott Solar states has an absorption level of 95% and radiates 14% of its heat at temperatures of around 400 degrees Celsius. The steel pipe is surrounded by a vacuum-isolated concentric borosilicate glass cladding tube with anti-reflex coating, which allows for over 96% penetration of solar radiation.

Approximately 22,500 absorption pipes are used in each power plant. The challenge when it comes to the longevity of the tubes is the interface between the steel and cladding tubes, which are

sealed to form an intermediate vacuum. The different thermal expansion of the steel tube and the glass cladding is compensated by a metal bellows.

A heat transfer medium circulates in the pipes, the so-called heat transfer fluid (HTF). The captured solar radiation heats the fluid, which then flows to the power block and through a heat exchanger, thus producing steam for the turbine. According to the EU Dangerous Substances Directive 67/548/EEC, the fluid is classified as non-hazardous.

### **Parabolic mirrors**

The parabolic mirrors are made of 4 millimeter-thick, silver-coated, curved white glass. The silver coating has an additional protective coating. The mirrors follow the course of the sun and reflect solar radiation onto the absorption pipe.

The Flabeg Group produced and supplied the parabolic mirrors for Andasol power plants 1 and 2 in its factory in Furth-im-Wald, Germany. According to the manufacturer, they have a reflective level of about 93%. Type RP-3 mirrors come in two different sizes for the interior-mounted and the exterior-mounted mirrors with an area of 2.79 and 2.55 square meters respectively. The power plants each have a total of 209,664 mirrors in their collectors. A laser scan checks each mirror's curve at 1,000 measuring points per mirror.

The mirror is anchored at four points to the steel structure. The mirrors, mountings and adhesives all have the same expansion coefficient, guaranteeing durability even under extreme temperature fluctuations. The mounting elements are made from special ceramics giving them a high level of mechanical strength and are non-corrosive. Flabeg has already delivered parabolic mirrors to the existing facilities in California's Mojave Desert. Recent samples have proven that, even after two decades of use, a loss in quality can hardly be detected. Rioglass Solar S.A. of Mieres/Asturia, Spain, produced the mirrors for Andasol 3.







### Storage tank

The Andasol power plants have a thermal storage tank allowing the power plants to provide scheduled power, thus the plants can operate even on overcast days or after sunset. The heat required for this is stored in a molten salt mixture, which is 60% sodium nitrate ( $\text{NaNO}_3$ ) and 40% potassium nitrate ( $\text{KNO}_3$ ). Both materials are used in food production as preservatives and as fertilizer. The liquid salt thermal storage functions under atmospheric pressure and consist of two tanks per power plant, measuring 14m in height and 36m in diameter. During the pumping process from the “cold” to the “hot” tank, the molten salt mixture absorbs additional heat at an outlet temperature of approx. 290°C, where it is heated to a temperature of

390°C. A full storage tank can be used to operate the turbine for about 7.5 hours. Molten salt has been used in different industrial applications for about 609 years to date, e.g. in galvanizing. Since then, over 3,000 plants working with molten salt are in operation to date. Solar Two in Barstow, California served as the reference project for the thermal storage tanks in the Andasol power plants because it had the same salt mixture – even though the storage tank was smaller. When the time comes to decommission the power plants at the end of their lifetime, the salts can be crystallized and removed in their raw state to be used thereafter in other applications e.g. in agriculture.

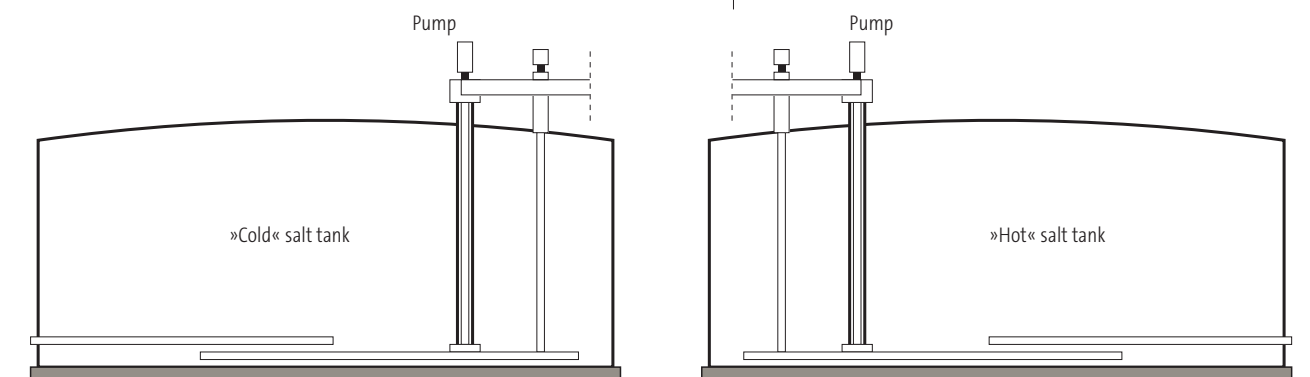

### **Supply point**

The thermal storage tank allows the Andasol power plants to supply electricity regularly into Spain's high-voltage electricity grid. Other renewable energies like wind are not able to supply electricity in a plannable way and require reserve power plants in order to maintain stability in the grid. Access for these non-plannable forms of energy into the Spanish high-voltage grid is thus limited. As an expression of its approval of the advantages offered by solar-thermal power plants, the operator of Spain's national grid, Red Eléctrica de España (REE), classified the Andasol power plants as "predictable" sources of electricity. This not only eased the permit process for granting access to the high-voltage grid, but also made it possible to increase the percentage of renewable energy in the state's energy mix because of the stabilizing effects of solar-thermal power plants. A substation has been built near the town of Huéneja about seven kilometers southeast of the power plant site for feeding the electricity into the grid.

### **Power supply contracts**

The Spanish energy supplier Endesa purchases electricity from the Andasol power plants in accordance with Spanish energy law, which states that the power plants are permitted to feed in a maximum of 50 MW into the grid. The power supply contract includes general technical standards and conditions as well as the implementation of programming and the after-sales service for electricity production.



## Regulatory framework in Spain

Spain is highly dependent on imported energy. Almost all petroleum and natural gas as well as 70% of its coal have to be imported. However, it has more than enough of one of the most environmentally friendly and cheapest sources of energy in the world – the sun. The Spanish government's support plan "Plan de Fomento de Energías Renovables (PER)" envisions the expansion of solar-thermal power plant capacity to 500 MW by 2010. Spain's Ministry for Energy and Industry wants to increase the annual volume of electricity produced in solar-thermal power plants to about 4,000 GWh, which is the equivalent of the capacity of about 25 Andasol power plants.

### Government-guaranteed feed-in tariffs for solar thermal electricity

Spain, like Germany, sponsors renewable energy with feed-in tariffs, especially solar energy production. These funding regulations are the result of Spanish Law 54/1997 dated November 27, 1997, pertaining to the electricity industry. This law is further specified by regulatory statutes in the form of Royal Decrees, the final being Royal Decree 661/2007. Solar-thermal power plants have their own feed-in arrangements, which differ from the funding guidelines for photovoltaic plants.

The funding for solar-thermal power plants caters explicitly to nominal capacities of up to 50 MW per power plant. Spain is now one of the most attractive markets for the construction and operation of solar-thermal power plants because of the state-guaranteed funding regulations.

Unlike in Germany, the operator of a plant can choose between two feed-in arrangements every year in Spain. He can decide between delivering energy at a fixed price, i.e. at a tariff that remains constant throughout the year or to sell the energy produced directly on the day market, the futures market or through bilateral contracts. Should the operator choose the second variant, he will receive both the trading price on the market as well as an additional premium.

### Option 1 (fixed tariff):

Solar thermal electricity receives a feed-in tariff of EUR 0.278399 per kWh\*.

### Option 2 (market option):

Solar thermal electricity is reimbursed with the market price, which was up to 0.15841 per kWh from 2001 to 2007 at the spot market in Spain, plus an additional premium amounting to EUR 0.262509 per kWh\*. The resulting total reimbursement is limited to a maximum of EUR 0.355499\* kWh. At the same time a minimum total reimbursement of EUR 0.262548 is guaranteed. The market option presents an opportunity for significantly higher income through the production of well-remunerated peak load electricity. This option is interesting as soon as the adequate experience of running a power plant has been gained and a prognosis overview predicting the volume of solar radiation is available (see the graphs below).

Feed-in tariff for one kWh\*

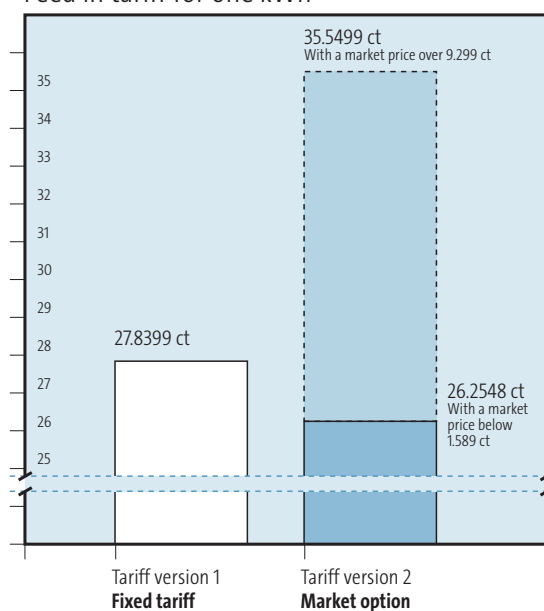

\* The numbers stated correspond to the feed-in tariff for 2008 determined in the document "Orden ITC/3860/2007", dated December 28, 2008. This annually updated document contains the tariff determined in the Real Decreto 661/2007 as well as the inflationary adjustment also provided for in the Real Decreto.



**The Spanish consumer price index (IPC) is the basis for the adjustment of the feed-in tariff.**

2000	2001	2002	2003	2004	2005	2006	2007	Average 2000 - 2007
3,7%	3,1%	3,7%	2,3%	4,1%	4,2%	2,4%	4,3%	3,5%

Source: Instituto Nacional de Estadística

Funding (price per kilowatt hour in the fixed tariff and the premium in the market option) is guaranteed for 25 years. After 25 years, the feed-in tariff is reduced to 80% of the then applicable tariff.

The government-guaranteed feed-in tariff is annually adjusted to inflation, based on the Spanish consumer price index IPC (Indice de Precios al Consumo). Until December 31, 2012, 0.25 percentage points of the relevant annual alteration in the IPC will be deducted, and 0.50 percentage points will be deducted thereafter.

**Further conditions for feed-in tariffs**

The directives governing Spanish funding policies were set down in the funding policy plan “Plan de Fomento de Energías Renovables (PER) 2005-2010”. Support is intended for the development of 500 megawatt (MW) solar-thermal energy plants until then. Since 2008, a new plan for renewable energy is being prepared for the period thereafter (2011-2020). It will incorporate Spanish energy demand and will examine the reimbursement system for new projects. Royal Decree 661/2007 as well as PER 2005-2010 are valid for the entire lifespan of all solar-thermal power plants already operating on the Spanish grid, like Andasol 1, for example.

Average spot market price in Spain

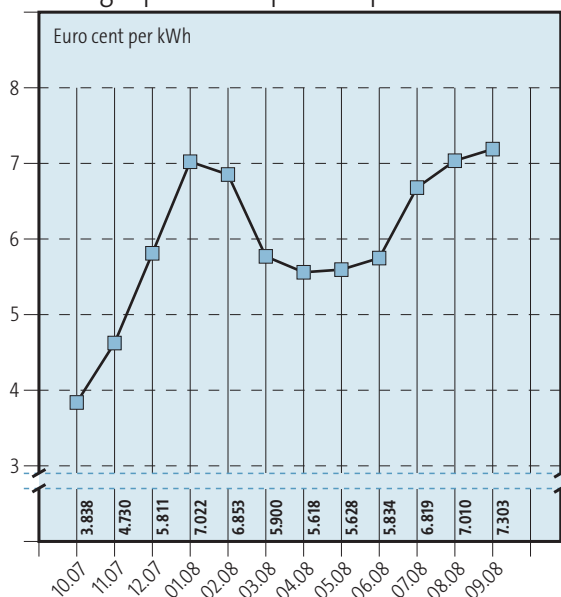

\*\* The hourly spot market price (here the average price over the last 12 months) is only relevant for version 2 (market option).  
Source: Operador del Mercado Ibérico de Energía – Polo Español, S.A. (OMEL)

## Project partners



### **Project developer: Solar Millennium AG**

Solar Millennium AG initiated and developed the Andasol power plants. The global company is active worldwide in the area of renewable energy with a focus on solar thermal power plants with capacities ranging from 50 MW to 250 MW. The company was founded in 1998 and has been listed on the OTC segments of the Munich and Frankfurt Stock Exchanges since 2005 as well as on the exchanges in Berlin and Stuttgart and in the Xetra electronic trading system. Solar Millennium, along with its subsidiaries, specializes in parabolic trough power plants. The company covers all important business sectors of the value-chain for solar-thermal power plants, from project development and financing to technology and the turn-key construction of power plants, to the operation and ownership of power plants. Flagsol, a technology subsidiary of Solar Millennium is responsible for the engineering and technical construction, planning, and construction supervision on the solar field.

Project development companies on site take care of all preparation work within the framework of project development, e.g. searching for sites and evaluating them, securing lands and rights, feed-in and funding as well as all other permit procedures and contractual negotiations.

Subsidiary Milenio Solar Desarrollo de Proyectos S.L. in Madrid is responsible for project management in Spain. To assure that local citizens feel involved in the project development, Milenio Solar has an office in the town of Aldeire, where the power plants are to be built and which is staffed by local residents. Andasol 1 is Europe's first parabolic trough power plant and was developed by Solar Millennium. In addition to sister projects Andasol 2 and Andasol 3, further projects are being developed around the world with a total capacity of over 2,000 megawatts. Regional focus is currently on Spain, USA, China and North Africa. In Egypt, the Solar Millennium Group is participating in the construction of parabolic trough facilities for a hybrid power plant there, which will use both natural gas and solar energy to produce electricity.

The ACS/Cobra Group purchased shares in the power plant company Andasol 1 Central Termosolar Uno, S.A. from Solar Millennium AG in 2003; and in the power plant company Andasol 2 Central Termosolar Dos, S.A in 2005. Afterwards, Milenio Solar Desarrollo de Proyectos, S.L took over the project development for the power plants at the request of the power plant companies.

**General contractor:**

A consortium made up of Cobra Instalaciones y Servicios S.A. with 80% and Sener Ingeniería y Sistemas, S.A. with 20% was responsible for the construction of Andasol 1 and 2. Solar Millennium gave the contract to subsidiary Marquesado Solar S.L. for the construction of Andasol 3, which then formed a project company responsible for the Early Works, which in turn were carried out by a consortium made up of MAN Solar Millennium GmbH of Essen, Germany and the Spanish equipment manufacturer Duro Felguera S.A. Energía of Gijón (Spain). The consortium will complete construction of the solar power plant by the beginning of 2011 under the leadership of MAN Solar Millennium GmbH.

**– Cobra Instalaciones y Servicios S.A. .**

Cobra Instalaciones y Servicios S.A. belongs to the Cobra Group, which is part of the Spanish construction company ACS (Actividades de Construcción y Servicios S.A.). The ACS group has its headquarters in Madrid and is one of the three largest construction companies in Europe with 125,000 employees and sales of over EUR 20 billion. The ACS Group supervises all areas of large-scale infrastructure projects like motorways, railway construction, harbor facilities, airports, and power plants. The Cobra Group now owns 75% of the equity in Andasol 1 and 2 and is responsible for the construction of these power plants.

**– Sener Ingeniería y Sistemas, S.A.**

Sener Ingeniería y Sistemas, S.A. which has its headquarters in Las Arenas, Spain is a company which specializes in providing engineering services and is also active in areas such as aeronautics, shipping, energy and technology, and power plant development.

**– MAN Solar Millennium GmbH**

MAN Solar Millennium GmbH is a joint venture combining MAN Ferrostaal AG and Solar Millennium AG for project development, financing and for the turnkey construction of solar thermal power plants with capacities ranging from 20 to 250 megawatts. Each company owns 50 percent of the joint venture. MAN Solar Millennium profits from the expertise of its parent companies: MAN Ferrostaal supplies its experience as a general contractor and equipment manufacturer as well as the financial strength necessary for international business. Solar Millennium is supplying the joint venture with proven, economically feasible technology as well as long-term experience in the development and implementation of solar power plants. Solar Millennium, together with its 100% subsidiary Flagsol GmbH, provides the technology for parabolic trough power plants – a proven, reliable technology in which the company is a worldwide leader.

**– Duro Felguera S.A. Energía**

One of the Duro Felguera Group specializations is turnkey construction projects in the energy sector. It has almost 150 years of experience in various industrial areas, and the company is now developing integrated projects for natural gas and steam power plants, industrial facilities, and fuel storage tanks. Duro Felguera is responsible for the complete execution of the project. The company is general contractor and thereby assumes responsibility for the construction, start-up and operation of the facilities.



### Engineering

Sener Ingeniería y Sistemas, S.A is assuming responsibility for the conventional sections of the power plant like the turbines, generators, and plant periphery in Andasol 1 and 2. Flagsol GmbH of Cologne will provide the engineering for the solar field. Flagsol is a 100% subsidiary of Solar Millennium AG. The work package includes the design and planning of the solar field as well as supervising on-site construction. In addition, Flagsol will provide the hardware and software for the solar field controls. Some of the staff has experience dating back to the implementation and operation of the first parabolic trough power plant in California in the 1980's. The company is constantly working on collectors for parabolic trough power plants. Flagsol will also be responsible for the technological design of the solar field in Andasol 3 (status: February 2009).

### Power plant owner

Central Termosolar Uno, S.A. with headquarters Aldeire, Spain is the owner of Andasol 1. Shareholders in this power plant company are Cobra Sistemas y Redes, S.A. with headquarters in Madrid, which owns 75% and is a company within the ACS/Cobra Group and Solar Millennium Verwaltungs GmbH, which own 25%. Central Termosolar Uno, S.A. with headquarters Aldeire, Spain is the owner of Andasol 2. Shareholders in this power plant company are Cobra Sistemas y Redes, S.A. with headquarters in Madrid, which owns 75% and Solar Millennium Verwaltungs GmbH, which owns 25%. Solar Millennium Verwaltungs GmbH has its headquarters in Erlangen, Germany and was founded on September 23, 1998.

Marquesado Solar S.L., Spain is the owner of the power plant Andasol 3 and is fully-owned by Solar Millennium AG.

### Bibliography market studies:

Greenpeace, ESTIA, IEA SolarPACES 2005:

Solar Thermal Power Now  
[http://www.solarpaces.org/Library/CSP\\_Documents/051006%20Greenpeace-Concentrated-Solar-Thermal-Power-Now-2005.pdf](http://www.solarpaces.org/Library/CSP_Documents/051006%20Greenpeace-Concentrated-Solar-Thermal-Power-Now-2005.pdf)

Sarasin 2007

Solarenergie 2007 – Der Höhenflug der Solarindustrie hält an.

Greenpeace/EREC 2007:

Globale Energie[r]evolution  
[www.greenpeace.de/masterplan](http://www.greenpeace.de/masterplan)

International Energy Agency (IEA) 2006:

World Energy Outlook 2006  
<http://www.worldenergyoutlook.org/2006.asp>



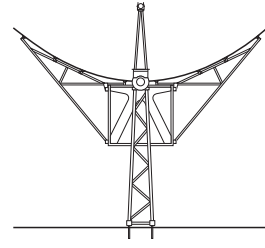
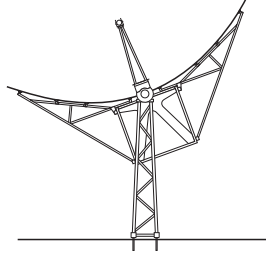
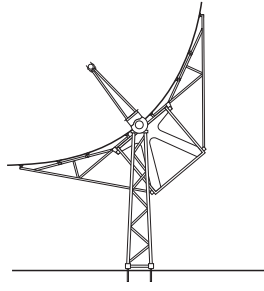
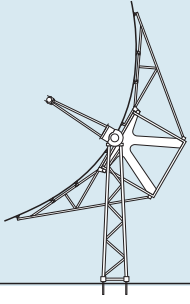

Solar Millennium AG  
Nägelsbachstraße 40  
D-91052 Erlangen  
Germany

Phone  
+49 9131 9409 - 0

Fax  
+49 9131 9409 - 111

E-mail  
[info@SolarMillennium.de](mailto:info@SolarMillennium.de)

Internet  
[www.SolarMillennium.de](http://www.SolarMillennium.de)

© Solar Millennium AG 2008